

ITEM	MATERIAL	COLOR	REMARKS
1	e-mateX FB-0432	BLACK	

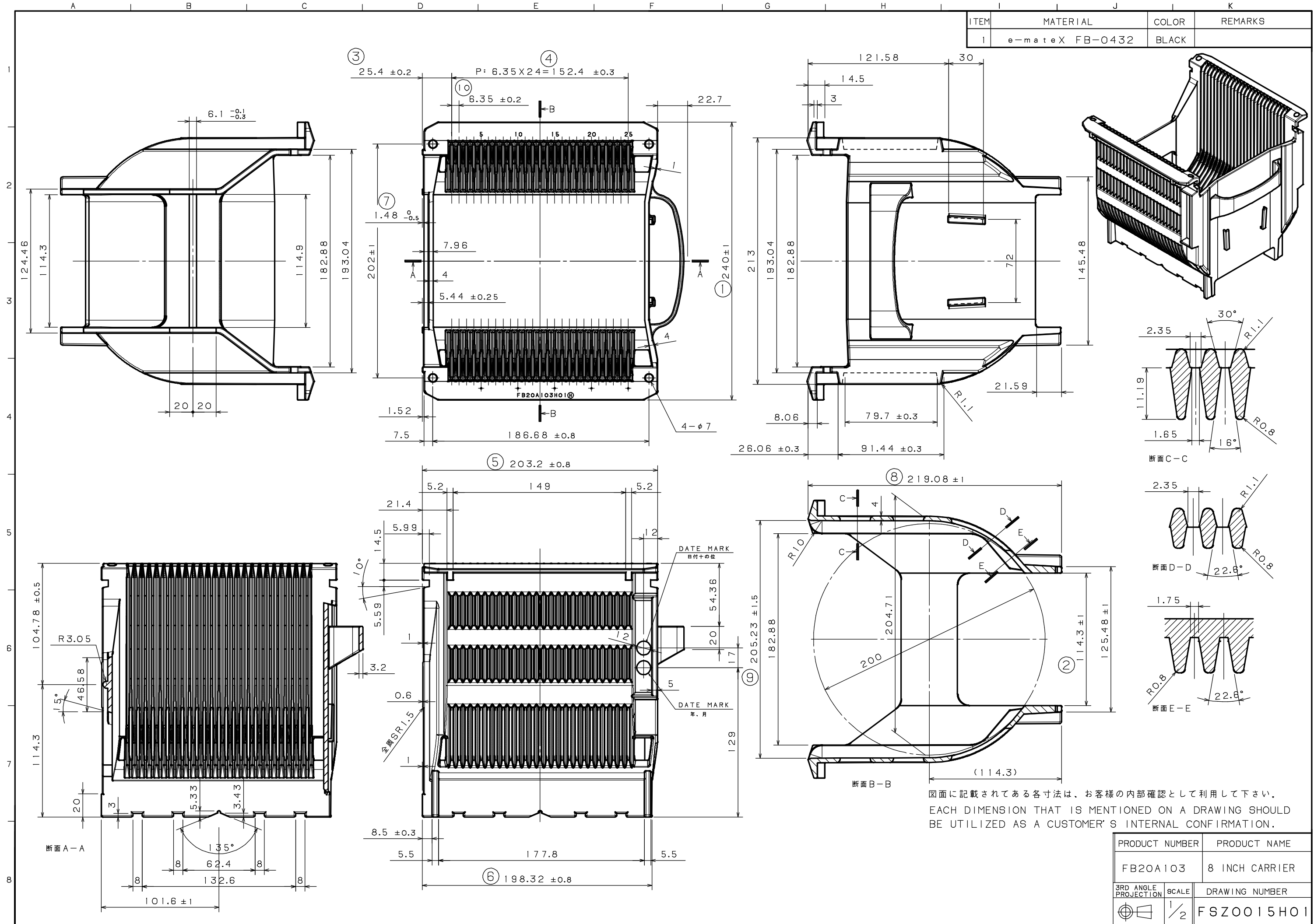

図面に記載されてある各寸法は、お客様の内部確認として利用して下さい。
 EACH DIMENSION THAT IS MENTIONED ON A DRAWING SHOULD BE UTILIZED AS A CUSTOMER'S INTERNAL CONFIRMATION.

PRODUCT NUMBER	PRODUCT NAME
FB20A103	8 INCH CARRIER
3RD ANGLE PROJECTION	SCALE
	1/2
DRAWING NUMBER	
FSZ0015H01	